



CONSTRUCTION SUPPLIES

Main Office

465 Locust St. • P.O. Box 8 • Dallastown, PA 17313
(717) 246-3095 • 1-800-632-9018

Branch Office

1490 Ritner Highway • Carlisle, PA 17013
(717) 249-6448 • 1-800-248-6590

www.tri-borosupplies.com

Fall - Winter 2013/2014 Newsletter

MEN'S & WOMEN'S

carhartt®
SALE 30% OFF

MANUFACTURERS LIST PRICE

WHILE SUPPLIES LAST!



Vests



**Hooded
Sweat
Shirts, Coats
& Jackets**



**Gloves &
Accessories**



**Men's &
Women's
Jeans**



**Coveralls &
Bib Overalls**

* Excludes Socks & Hi-Vests. Other merchandise not shown available in store.
Full Line Available. Hats Available.

You Can Now Find Us On FACEBOOK

Pricing in flyer good from December 1, 2013 until March 19, 2014

DUCT TAPE

UTILITY GRADE **1 CASE OR MORE**
24 Rolls per case
SKU# 061084 **\$4.39/roll**

ELECTRIC CORDS

25' 12/3 **\$17.50**
1 OUTLET SKU# 145043
50' 12/3 **\$39.95**
1 OUTLET SKU# 145044
100' 12 GA ... **\$69.95**
1 OUTLET SKU# 145060



TEMPORARY LIGHT SYSTEM

50 FT. SKU# 147230
\$99.95
100 FT. SKU# 147225
\$179.95



DELUXE HARD HAT LINER



MODEL #524 **\$3.79**
A - SKU# 103120
QUILTED GREEN..... **\$5.29**
B - SKU# 103121
ECONOMY LINERS.. **\$2.49**
C - SKU# 103100

SNOW SHOVELS

20" Deluxe Snow Shovel Pusher #SC2700
SKU# 755110 **\$24.49**
20" Poly Snow Pusher w/ Ergonomic Handle
#SC5350
SKU# 755109 **\$24.89**
18" Poly Snow Shovel D-Handle #SN1250
SKU# 755136 **\$13.59**
Poly Scoop Wood D Handle
#1681500
SKU# 755164
\$22.49
18" Blue Poly Coated Snow Shovel
#SN1000
SKU# 755142 **\$8.99**
Artic Blast 24" Snow Pusher
#1640000
SKU# 755116 **\$33.69**



THERMOMETER

MAX - MIN
\$23.95
SKU# 330060

TREDS OVER-THE-SHOE BOOTS

AVAILABLE IN SIZES: 
MEDIUM 8-10 SKU# 600249
LARGE 11-12 SKU# 600250
LARGE/X-LARGE 13-14 SKU# 600251
X-LARGE 15-16 SKU# 600252
XX-LARGE 17-19 SKU# 600253



\$49.79 /ea.

EPOXY

POWERS COLD WEATHER
EPOXY AC100 QUICK SHOT

\$15.79 /ea.
10 oz SKU# 211152
(12/Case)



SKU# 610130
PIGSKIN THINSULATE DRIVER (LARGE)
\$12.89



SKU# 610099
BROWN JERSEY (LARGE)
PER DOZEN
\$9.29



SKU# 610150
GRAY CHORE (LARGE)
\$2.89



SKU# 610070
HONEST ABE RED LINED JERSEY
\$1.79

WHILE SUPPLIES LAST

SALT 50LB BAGS

\$5.97 /bag

SKU# 090075

BUY A PALLET OF SALT AND PAY ONLY **\$5.39** /BAG

BULK SALT

\$90.00 per ton picked up

SKU# 090085

CALL FOR DELIVERED PRICES

IT'S TIME TO WINTERIZE

MAGNESIUM CHLORIDE 50LB FLAKE

\$14.69 /bag

SKU# 090060

BUY A PALLET OF MAGNESIUM CHLORIDE AND PAY ONLY **\$13.96** /BAG

Calcium 50LB BAGS

\$12.49 /bag

SKU# 090090

BUY A PALLET OF CALCIUM AND PAY ONLY **\$11.99** /BAG



IT'S TIME TO WINTERIZE

REINFORCED POLY

DELUXE (MAX KATZ)

- 20' X 100'**
SKU# 323010 **\$112.00**
- 32' X 100'**
SKU# 323014 **\$180.00**
- 40' X 100'**
SKU# 323017 **\$224.00**



CURING BLANKETS

- 6' X 25' SILVER R2.8**
SKU# 323063 **\$32.75**
- 6' X 25' SILVER R5.11**
SKU# 323065 **\$44.75**
- 12' X 25' SILVER R2.8**
SKU# 323073 **\$68.75**
- 12' X 25' SILVER R5.11**
SKU# 323075 **\$91.75**
- 8' X 25' BUBBLE R1.3**
SKU# 323078 **\$43.75**
- 8' X 125' BUBBLE R.08**
SKU# 323079 **\$189.75**



STRAPS- RUBBER

- (15")** SKU# 131085 **.99¢**
- (21")** SKU# 131095 **\$1.29**
- (31")** SKU# 131110 **\$1.49**

CANVAS TARPS

- 8'x10'**.....SKU# 130170 **\$66.50**
- 10'x10'** ..SKU# 130180 **\$72.69**
- 12'x12'** ..SKU# 130210 **\$97.20**
- 12'x16'** ..SKU# 130230 **\$126.90**
- 20'x20'** ..SKU# 130260 **\$264.29**

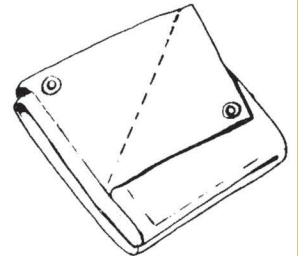

STEGO WRAP SPECIAL

- 10 Mil Class C 14' x 210'** ... SKU# 322030 **\$266.50**
- 10 Mil Class A 14' x 210'** ... SKU# 322035 **\$285.50**
- 15 Mil 14' x 140'** SKU# 322040 **\$295.50**
- Stego Tape 4" x 180'** SKU# 322050 **\$34.50**

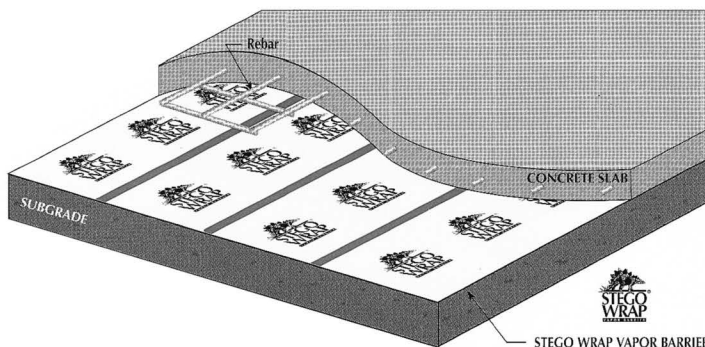

POLY TARPS

- | | |
|--|---|
| 8' x 10'
SKU# 130010 \$4.45 | 20' x 30'
SKU# 130100 \$33.95 |
| 10' x 20'
SKU# 130040 \$10.95 | 20' x 40'
SKU# 130110 \$44.95 |
| 20' x 20'
SKU# 130090 \$21.95 | 40' x 60'
SKU# 130140 \$119.95 |

POLYETHYLENE SHEETING



- 4 Mil 20' x 100'** Clear or Black **\$44.95**
SKU# 320100, 321010
- 6 Mil 20' x 100'** Clear or Black **\$67.50**
SKU# 320160, 321050
- 8 Mil 20' x 100'** Clear **\$91.95**
SKU# 320180
- 10 Mil 20' x 100'** Clear or Black **\$112.95**
SKU# 320190, 321080



CALL FOR PRICING

TRI-BORO SUPPLIES (800) 632-9018



Titan Waterproof 6" Boot - Safety Toe
Style# 26078



Ripsaw 9" Logger Waterproof, Insulated - Safety Toe
Style# 89656



Pit Boss 6" Work Boot - Soft Toe
Style# 33030

Available Product

Medium sized are immediately available. *Sizes 14, 15 medium and all wide sizes are special order. Please allow 14-21 days for special order deliveries.

WHILE SUPPLIES LAST!



Insulated/Waterproof 6" Work Boot - Steel Toe
Style# 65016



Timberland PRO 6" Waterproof - Soft Toe
Style# 65030



Pit Boss 6" Work Boot - Steel Toe
Style# 33034



Expertise Hiker Boot - Steel Toe
Style# 50500



Resistor Waterproof 6" Boot - Safety Toe
Style# 89661



Waterproof PowerWelt 6-inch Boot - Steel Toe
Style# 47001

2013-2014 WINTER HEATER SALE

MASTER · UNIVERSAL · HEAT STAR



PROPANE (RADIANT)

SKU# 750028	8-14,000 BTU MH12T	\$45.50
SKU# 750029	10-15,000 BTU MH15T	\$45.50
SKU# 750030	8-28,000 BTU MH24T	\$96.50
SKU# 750040	8-42,000 BTU MH45T	\$128.95
SKU# 750045	33,000 BTU W/STAND 36AP	\$189.00
SKU# 750068	30,000 BTU 30FAS	\$119.00
SKU# 750069	15-20-25,000 BTU UNIVERSAL 25-VC	\$79.00
SKU# 750071	30-80,000 BTU 80VCA/VCB	\$98.95
SKU# 750080	75-200,000 BTU HS200CV	\$129.95
SKU# 750100	RADIANT PROPANE 100RA	\$199.00
SKU# 750135	40-80000 BTU TC113	\$119.00

PROPANE (FORCED AIR)

SKU# 750070	35,000 BTU FALP HS35FA	\$149.00
SKU# 750108	50,000 BTU HS60 FAV	\$179.00
SKU# 750075	75,000 BTU 75FAS	\$149.00
SKU# 750072	85,000 LP 85-FAC	\$149.00
SKU# 750119	75-125,000 BLP125V	\$179.00
SKU# 750120	125-170,000 BTU HS170FAVT	\$359.00
SKU# 750122	125-170,000 W/STAT TB108	\$329.00
SKU# 750123	225-375,000 BTU BLP375AT	\$589.00
SKU# 750124	175-350,000 BTU 3500 FACV	\$529.00
SKU# 750125	175-350,000 HS400FAVT	\$629.00
SKU# 750130	400,000 BTU W/STAT MH400FAVT	\$619.00

KEROSENE (FORCED AIR)

SKU# 750138	50,000 BTU HEATSTAR HS50K	\$229.00
SKU# 750142	70,000 BTU MASTER B70ET	\$219.00
SKU# 750145	75,000 BTU HEATSTAR HS75KT	\$259.00
SKU# 750150	125,000 BTU HS125KT W/ THERMOSTAT	\$397.00
SKU# 750156	175,000 BTU HS175KT W/ THERMOSTAT	\$429.00
SKU# 750165	610,000 BTU HS6000 DF	\$2,169.00
SKU# 750158	210,000 BTU HEATSTAR HS210KT	\$539.00
SKU# 750160	400,000 BTU HEATSTAR HS4000DF	\$1895.00

ELECTRIC

SKU# 750024	1500W UTILITY	\$18.95
SKU# 750026	VERSA HEAT 1500W VHE-200	\$295.00



PRICES GOOD WHILE SUPPLIES LAST!

CONCRETE EQUIPMENT

18" DOWNCUT - CONCRETE AND ASPHALT SAWS - MAX CUTTING DEPTH 6 3/4"

PRODUCT NOTES:

Wide "T" handles with rubber grips • Heavy-duty arbor shaft assembly with 18" blade capacity • Heavy-duty, 7-gauge steel frame & under-carriage eliminates bending & vibration, • Dual blade arbor cutting capabilities • Easy turn, large diameter crank for lowering and raising blade in and out of cut • Turn-to-lock throttle cable • Solid-steel handles and lifting bail for easy loading and unloading • Heavy-duty, anti-vibration engine mount • Screw boot belt tensioner prevents frame damage

IDEAL FOR: Short-run slab cutting, contraction joints, patch repairs in asphalt, traffic loop installation and trenching



DS-18
SKU # 450042

14" DOWNCUT - CONCRETE AND ASPHALT SAWS - MAX CUTTING DEPTH 4 3/4"

SK-14
SKU # 450040

PRODUCT NOTES:

Stable frame with wide wheel base
• Rear wheel shaft mounted end to end for great frame rigidity,
• Heavy-duty, 7-gauge steel frame, undercarriage and steel core wheels eliminate bending & vibration,
• Precision machined 1" arbor

IDEAL FOR: Short-run slab cutting, contraction joints, patch repairs in asphalt, traffic loop installation and trenching



20" SELF PROPELLED - CONCRETE AND ASPHALT SAWS - MAX CUTTING DEPTH 7 3/4"

SS-20
SKU # 450045

PRODUCT NOTES:

Stressproof, precision-machined, 1 1/32" steel arbor shaft
• Includes electric start, 12-volt battery and heavy-duty 15-amp charging system,
• Swing-away, rear 3-gallon fuel tank
• Screw-type depth control w/ lock guarantees accurate cutting

IDEAL FOR: Highway, road and bridge deck repair • Utility installation and/or traffic loop installation

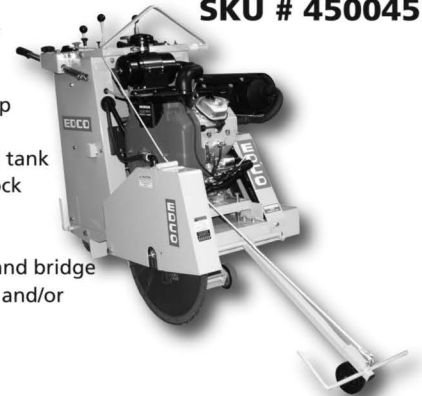

24" SELF PROPELLED - CONCRETE AND ASPHALT SAWS - MAX CUTTING DEPTH 9 1/2"

SS-24
SKU # 450046

PRODUCT NOTES:

Self-Propelled gear drive system
• Stressproof, precision-machined, 1 1/4" steel arbor shaft
• Includes electric start, 12-volt battery and heavy-duty 15-amp charging system
• Inside mounted, 3-gallon fuel tank
• Screw-type depth control w/ lock guarantees accurate cutting
• Heavy-duty lifting bail

IDEAL FOR: Highway, road and bridge deck repair • Utility installation and/or traffic loop installation



26" SELF PROPELLED - CONCRETE AND ASPHALT SAWS - MAX CUTTING DEPTH 12"

THIS SAW CAN BE FITTED WITH A 30" BLADE GUARD TO ACCOMMODATE A 30" DIAMOND BLADE

SS-26
SKU # 450048

PRODUCT NOTES:

Stressproof, precision-machined, 1 3/4" steel arbor shaft
• Includes electric start, 12-volt battery and heavy-duty 30-amp charging system
• Locking depth control allows operator to easily return to same depth, cut after cut
• Positive-traction, chain-drive rear axle prevents slippage and improves cutting speeds
• Swing-away, rear 6.4-gallon fuel tank

IDEAL FOR: Highway, road and bridge deck repair • Utility installation • Traffic loop installation • Airport construction



Hammer Specials



1-9/16" SDS-max® Combination Hammer
11240 Sku# 020187
\$410.00



1-9/16" SPLINE
11247 Sku# 020136
\$419.00

1-9/16" SDS-max® Demolition Hammer
11318EVS Sku# 020124
\$549.00



12 lb. SDS-max® Demolition Hammer
11321EVS Sku# 020123
\$559.00



SDS-max® Demolition Hammer
11316EVS Sku# 020126
\$799.00



1-5/8" SDS-max® Rotary Hammer
11264EVS Sku# 020122
\$629.00



1-5/8" SPLINE
11265EVS Sku# 020137
\$619.00

7/8" SDS-plus® BULLDOG Rotary Hammer
11224VSR Sku# 020186
\$169.00



1-1/8" Hex Breaker Hammer Deluxe Kit
with Chisels & Cart
BH2760VCD Sku# 020239
\$1499.00
BH2770VCD Sku# 020241
\$1889.00



SPECIAL OFFER! 20% Off any drill bits
when you buy a Bosch Drill

(Offer ONLY valid at the time of drill purchase.)

Offers Good While Supplies Last



695 SERIES CONCRETE AND UTILITY CHAIN SAWS

HAVE IT YOUR WAY from Triboro Construction Supplies



695GC

- 94cc, 2-stroke engine
- 24 lbs (with bar and chain)
- 6.4 hp (4.8kW)
- 14" (35 cm) or 16" (40cm) cutting depth



680GC

- 76.5cc, 2-Stroke Engine
- 21 lbs.
- 5 hp
- Up To 14" (35cm)

680GC with TwinMAX



SKU#	DESCRIPTION 680GC	PROMO PRICE
4500545058	680GC-12 Gas Saw Package, with 12 in (30 cm) Guidebar & TwinMax-29 Chain	\$895
4500545099	680GC-14 Gas Saw Package, with 14 in (35 cm) Guidebar & TwinMax-32 Chain	\$949

695GC with TwinMAX



SKU#	DESCRIPTION 695GC	PROMO PRICE
4500544107	695GC-14 Gas Saw Package, with 14 in (35 cm) Guidebar & TwinMAX-32 Chain	\$1,695
4500544108	695GC-16 Gas Saw Package, with 16 in (40 cm) Guidebar & TwinMAX-35 Chain	\$1,749



695PG

SKU#	DESCRIPTION 695PG	PROMO PRICE
4500545018	695PG-16 Gas Saw Package, with 16 in (40 cm) Guidebar & PowerGrit Chain	\$2,095



Tri-Boro Construction Supplies

Dallastown
465 Locust St. Dallastown, PA 17313
(800) 632-9018

Carlisle
1490 Ritner Highway Carlisle, PA 17013
(800) 248-6590

© 2013 ICS | Blount, Inc. Pricing and specifications subject to change without notice. All rights reserved. ICS, WallWalker, SpeedHook, SealPRO, FORCE4 and PowerGrit are registered trademarks of ICS. The best way to cut concrete, DCT, TSS, ProFORCE and TwinMAX are trademarks of ICS 0312.





ADS IS YOUR STORMWATER SOLUTIONS PROVIDER

Advanced Drainage Systems, Inc. has the solutions needed for all of your stormwater needs.

ADS Singlewall pipe is available in diameters of 4"-6" and is perfect for residential storm drainage for foundation, driveway culverts, downspout run off and may be used for high edge drains and other construction applications. The pipe is available in 10' sticks or coils.

N-12[®] dual-wall corrugated high-density polyethylene pipe is available in diameters from 4"-60". N-12 may be used for storm sewers, retention/detention, culverts/cross drains and ditch enclosures.



Singlewall Coil



Singlewall Pipe



N-12 Dual-Wall Pipe

For more information on these and all ADS products please call Tri-Boro Construction Supplies at 1-800-632-9018 or 1-800-248-6590



DrainTech® DRAINAGE SOLUTIONS

DrainTech products have been designed to provide maximum performance with minimal maintenance. In addition, they are made from rigid lightweight polyolefins for easy installation. DrainTech products work with a full line of ADS high-density polyethylene pipe and fittings for a complete drainage system.



DrainTech® Basins

- Wet Areas in Yards & Lawns
- Golf Course Fairways
- Athletic Fields
- Patios, Garages & Driveways



DrainTech® Pro+ Grates

- Use with pipe or channels
- Designed for heavier loads
- Round grates are 12" - 24"
- ADA Compliant



DrainTech® Pro+ Channels

- Light Traffic Areas
- Garage Door Entrances
- Patios
- Landscape Areas



DrainTech® Pro+ Valve Boxes

- Side ports allow multiple outlets
- Available in various colors
- Numerous lid styles
- Overlapping lids

CONCRETE EQUIPMENT



The World's Most Useful Vibrators for Concrete.

PR 100 Two Handle Screed



PR 100 Power Unit



Tool Free Bar Connection



Multi Vibe Power Screed Assembly w/Screed SKU# 0322142

8' Light Screed SKU# 0322163 (Promo) **\$1799.00**

10' Light Screed SKU# 0322164 (Promo) **\$1850.00**

12' Light Screed SKU# 0322165 (Promo) **\$1898.00**

14' Light Screed SKU# 0322166 (Promo) **\$1950.00**

The most rigid screed bar on the market with extra heavy cutting and trailing edges.



Walk Behind Power Trowels

36" J36H55 w/5.5 HP Honda & Quick Pitch SKU # 442001 **\$2319.00**

36" J36H90H w/9 HP Honda w/Quick Pitch SKU # 442005 **\$2489.00**

46" B46H11H w/11 HP Honda w/Quick Pitch SKU # 442009 **\$2779.00**

Stone Trowels Walk Behind Power Trowel



CF304 4 Blade 5 HP Honda SKU # 443010 **\$1449.00**

CF364 4 Blade 5.5HP Honda SKU # 443020 **\$1849.00**

CF-364 4 Blade 8 HP Honda SKU # 443030 **\$2029.00**

CF-364 4 Blade 8 HP Honda w/ Pro Pitch SKU # 443039 **\$2195.00**

CF464 4 Blade 11 HP Honda w/ Pro Pitch SKU # 443043 **\$2449.00**

CF464 4 Blade 11 HP Honda SKU # 443044 **\$2289.00**

Bartell Walk Behind Power Trowel (available with Insta-Pitch)

24" B 424 4HP Honda Engine SKU # 442098 **\$1995.00**

36" B 436 5.5HP Honda Engine SKU # 442100 **\$1789.00**

36" B436 9HP Honda Engine w/ Insta-Pitch SKU # 442102 **\$2169.00**

46" B 446 11HP Honda Engine SKU # 442103 **\$2259.00**

46" B 446 11HP Honda Engine w/ Insta-Pitch SKU # 442104 **\$2649.00**



More than 40 years ago, Bartell Power Trowels entered the market place and many of those early trowels are still in operation. From the start and continuing today we build trowels that allow a contractor to start sooner, finish better and that last longer. A Bartell Power Trowel is designed, engineered and built for a competitive edge: Greater productivity, Less down time, and Longer machine life.



POWER WASHERS

Model - 4000SP

4000 PSI @ 3.3 GPM

SKU# 43860663

\$895.00 /Each



Model - PS4240

4200 PSI @ 4.0 GPM

SKU# 43860456

\$996.00 /Each

WHILE SUPPLIES LAST!

Available at



CONSTRUCTION SUPPLIES

BOLLARD COVERS

NEVER PAINT AGAIN! • MAINTENANCE FREE BOLLARD COVERS

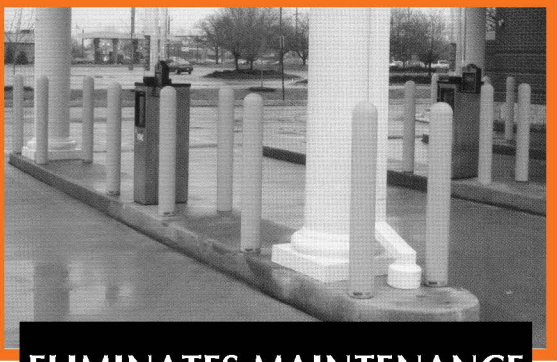

ELIMINATES MAINTENANCE
NEVER PAINT AGAIN!



Before



After

WHY CHOOSE BOLLARD COVERS?

- Maintenance Free
- Fits all pipe sizes 3" - 10"
- Both 1/8" and 1/4" wall thickness available
- Quick and easy installation
- Available in any color
- Mold-In and Mold-On logo options
- Decorative styles available



ANY COLOR AVAILABLE
VARIETY OF COLORS, STYLES,
AND SIZES

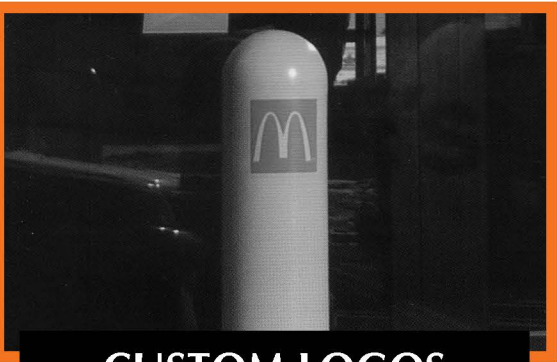

CUSTOM LOGOS
PERSONALIZE FACILITY
APPEARANCE

Product Specifications:

- Available in 1/8" and 1/4" nominal wall thickness durable plastic.
- Fits pipe sizes from 3" - 10"
- Cut to custom heights
- Available in any color



METABO SPECIALS!

Offer valid while supplies last

W8-115 Quick #600264420 4 1/2" Angle Grinder SKU #020004

Max. Wheel Diameter	: 4 1/2"
No-load Speed RPM	: 10000
Amps	: 8.0
Spindle Thread	: 5/8"-11
Rated Input Watts	: 800



- Quick wheel change system
- Switch with lock on capability
- AC/DC capability
- Spindle lock
- Aluminum die-cast gear housing
- Burst proof guard w/7 stops
- Anti-vibration side handle
- Auto stop carbon brushes
- Metabo slip clutch
- Winding protection grid

\$139

WE14-150 Quick #600160420 6" Electronic Angle Grinder SKU #020006

Max. Wheel Diameter	: 6"
No-load Speed RPM	: 8000
Amps	: 12.2
Spindle Thread	: 5/8"-11
Rated Input Watts	: 1400



- Quick wheel change system
- Switch with lock on capability
- Current interruption protection
- Spindle lock
- Aluminum die-cast gear housing
- Burst-proof guard w/7 stops
- Anti-vibration side handle
- Electronic winding temperature monitor w/LED display
- Metabo slip clutch
- Auto-stop carbon brushes
- Winding protection grid
- Electronic soft start feature
- Electronic speed stabilization

\$259

W24-180 #606445420 7" Angle Grinder SKU #020014

Max. Wheel Diameter	: 7"
No-load Speed RPM	: 8500
Amps	: 15.0
Spindle Thread	: 5/8"-11
Rated Input Watts	: 2400



- Spindle lock
- Anti-vibration (3 position) side handle
- Twister 3 position rear handle
- Burst proof guard w/7 stops
- Winding protection grid
- Safety lock to prevent accidental switching on of tool
- Auto stop carbon brushes
- AC/DC capability

\$229

DUSTLESS TUCKPOINTING GRINDER SYSTEM WQ1000 SKU #020053



Max. Wheel Diameter	: 5"
No-load Speed RPM	: 10,000
Amps	: 8.5
Spindle Thread	: 5/8"-11
Rated Input Watts	: 1010



Dust Director tuck pointing guard accepts 4", 4-1/12", 5" and 6" diamond blades. Port is 2". Not for use with Type 1 or Type 27 bonded abrasives. Swivels when approaching an inside corner.

- QUICK wheel change system: eliminates need for spanner wrench
- Winding protection grid: protects motor from harmful debris
- Metabo safety clutch: protects operator from kickback

\$239



3-YEAR WARRANTY
WITH ON-LINE REGISTRATION
WWW.METABO.COM/XXL



metabo[®]
work. don't play.

facebook.com/Metabo

blog.metabousa.com

twitter.com/MetaboTools

youtube.com/MetaboTools

Plasticade A-Frame Barricade

- Rugged, "double-wall" A-Frame plastic barricade
- Perfect for crowd control and road closures
- Unique I-Beam board creates a rigid barricade system and protects the sheeting
- A-Frame legs are designed to receive flashing lights and can be internally ballasted with sand
- Boards weight 1 lb. per foot and are available in three lengths (6', 8', and 10') 8' In Stock.
- A-Frame Leg Dimensions: 28"W x 42"H (board opening - 2"W x 8"H) Weight: 5 lbs.
- Plasticade A-Frame Barricades are sold as sets or as component parts

\$149.⁹⁰

Sold with 2-8^{FT} I-Beams

SKU# 650670

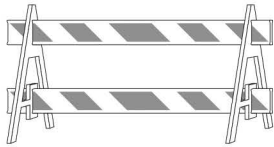

Two Boards Set



One Board Set



Remove plug and fill with sand to ballast

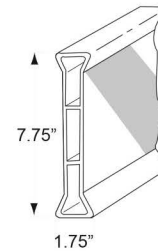

I-Beam Board
I-Beam's recessed face protects the sheeting



Type "A" and "C" Barricade Warning Lights

Model 400 12 Volt **\$20.⁹⁵/ea**
SKU# 650640

6 Volt Batteries **\$3.⁹⁵**
SKU# 150020



- Upper case design eliminates the need for the rubber neck ring.
- Hi-Impact polypropylene - UV stabilized
- Moisture proof circuit using the latest state of the art electronic components
- Reverse polarity protected
- Available in flashing or steady burn 6 or 12 volt with or without photo electric switch
- Standard flash rate in 65 +/- 10 FPM and on time is a minimum of 10% of the flash cycle
- Special purpose circuits with various flash rates and on times are available upon request

FLOOR PROTECTION

cover (guard)[®]
every way protected

Flame Retardant Temporary Protection



The original cover guard product was developed for the temporary protection of all types of floor finishes. It is also suitable for protecting walls, bulkheads, weatherdecks, furnishings and for wrapping and containment. It was specifically designed for use within the industrial sectors of rail, aviation, naval, cruise, ferry, luxury yacht, offshore, construction, for new building, refit, repair and maintenance.

Flame retardant polyethylene deck plate with a non-slip diamond pattern.

CG1036DP - 35.8" x 393.7'

CG2536DP - 35.8" x 180.4'

CG1336DP - 35.8" x 360.9'

CG4036DP - 35.8" x 118.1'

See salesperson for details.



Main Office 465 Locust St. P.O. Box 8 Dallastown, PA 17313 (717) 246-3095 1-800-632-9018

Email: sales@tri-borosupplies.com www.Tri-BoroSupplies.com

METABO SPECIALS!

Offer valid while supplies last

SBE-751 #600863620
1/2" Hammer Drill
SKU #020002



Capacity in concrete	: 3/4"
Capacity in mild steel	: 1/2"
Capacity in soft wood	: 1 9/16"
No-load Speed RPM	: 0-1000/0-3100
No-load BPM	: 0-59000
Amps	: 6.5
Rated Input Watts	: 750

- Variospeed (V) electronics
- LongLife motor
- Aluminum die-cast gear housing
- Safety non-slip side handle
- 2-speed gear box
- Swivel cord connection
- Reversing switch
- Metabo slip clutch
- Aluminum die-cast gear housing
- Winding protection grid

\$159

KHE-D24 #600223420
1" SDS Rotary Hammer
SKU #020024



Capacity in concrete	: solid bits-1"
Capacity in mild steel	: 1/2"
Capacity in soft wood	: 1 3/16"
No-load Speed RPM	: 0-1000
No-load BPM	: 0-4600
Amps	: 5.6
Rated Input Watts	: 720

- Variospeed (V) electronics
- LongLife motor
- 12 Chisel positions
- Percussion stop for drilling only operations
- Rotation stop for chiseling only operations
- Aluminum die-cast gear housing
- Reversing switch
- Metabo slip clutch
- Rubber coated handle
- Auto-stop carbon brushes
- Winding protection grid

\$198

KHE3250 #600637420
1 1/8" SDS Rotary Hammer
SKU #020033



Capacity in concrete	: solid bits-1 1/8"
Capacity in mild steel	: 1/2"
Capacity in soft wood	: 1 3/8"
No-load Speed RPM	: 0-1150
No-load BPM	: 0-4470
Amps	: 7.2
Rated Input Watts	: 800

- LongLife motor
- 12 Chisel positions
- Percussion stop for drilling only operations
- Rotation stop for chiseling operations
- Aluminum die-cast gear housing
- Reversing switch
- Metabo slip clutch
- Rubber coated handle
- Auto-stop carbon brushes
- Winding protection grid
- Swivel cord connection

\$349

KHE56 #600340420
1 3/4" SDS-Max Rotary Hammer
SKU #020036



Capacity in concrete	: (solid bits-1 3/4") (core bits-4")
No-load Speed RPM	: 0-450
No-load BPM	: 0-2840
Amps	: 14
Rated Input Watts	: 1300

- Rotation stop for chiseling operations
- 12 Chisel positions
- MVT vibratex handle
- Magnesium die-cast gear housing
- Impact reduction switch
- Metabo slip clutch
- Carbon brush wear indicator
- Auto-stop carbon brushes
- Winding protection grid
- Electronic speed stabilization
- 360° support handle

\$659



3-YEAR WARRANTY
 WITH ON-LINE REGISTRATION
WWW.METABO.COM/XXL



metabo®
work. don't play.



facebook.com/MetaboUSA



blog.metabousa.com



twitter.com/MetaboTools



youtube.com/MetaboTools



MODEL X-750
SKU# 450101
\$4,489.00



MODEL X-150
SKU# 450099
\$2,079.00



MODEL X-2000
SKU# 450105
\$9,589.00



MODEL X-4000
SKU# 450106
\$10,997.00



MODEL X450
SKU# 450100 **\$4,995.00**

MODEL GS1000
SKU# 450102 **\$6,589.00**

MODEL X2500
SKU# 450103 **\$15,689.00**

MODEL X4200
SKU# 450108 **\$18,995.00**

MODEL X-750, X-2000e, X-4000

These Prowler series gas saws were designed to be economical and durable while providing the same quality and performance as the traditional Soff-Cut saws. We now have a Prowler saw for all size jobs. Designed with durability in mind, the Prowler saws can be recognized by their distinctive roll cage style. Much like the entire line of Soff-Cut saws, the Prowlers work in conjunction with Soff-Cut blades and patented skid plates to allow Ultra Early Entry™ concrete cutting, which minimizes chipping and spalling while getting the job done the same day.

Husqvarna[®]

FLOOR SAWS



HUSQVARNA FS 6600 D
36" WALK BEHIND CONCRETE SAW
SKU# 450061

The FS 6600 D is a powerful and highly efficient saw. Its power / size ratio makes it an extremely versatile and super-productive saw in all cutting applications, particularly when the saw is equipped with the 3-speed gear box.



HUSQVARNA FS 4800 D
36" WALK BEHIND CONCRETE SAW
SKU# 450060

The FS 4800 D is a professional and very versatile floor saw for mid-size jobs. It is available in front pivot or rear pivot configurations. A rear pivot saw is recommended when maneuverability is key in road repairs jobs. The front pivot version is preferable for normal road sawing operations.



HUSQVARNA FS 520
20" WALK BEHIND CONCRETE SAW
SKU# 450054

Series of floor saws with engine options from 13 to 24 hp. The floor saws are developed with a clear focus on ergonomics and user friendliness, featuring many innovative solutions that make your job easier. Their unique transmission makes them ideal for more demanding jobs, despite their compact size.

weather guard®



\$479.00

Lo-Side Box Steel #185-3-01
SKU#43100185301



\$499.00

Lo-Side Box Alum #174-0-01
SKU#43100174001



\$499.00

Lo-Side Box Alum #174-5-01
SKU#43100174501



\$759.00

High-Side Box #272-3-02
SKU#43100272302



\$849.00

Superside Box #291-3-02
SKU#43100291302



\$679.00

Transfer Tank 70 GAL #352-3-01
SKU#43100352301

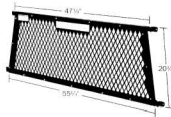

\$259.00

Truck Rack Screen #1259
SKU#43100001259



\$719.00

Steel Ladder Rack Long Bed #1275
SKU#43100012750

KNAACK®



\$859.00

StorageMaster Chest #89
SKU#43000000089



\$1,429.00

JobMaster Cabinet #129
SKU#43000000129



\$819.00

StorageMaster Chest #69
SKU#43000000069



\$329.00

JobMaster Chest #36
SKU#43000000036



\$1,049.00

StorageMaster Chest #90
SKU#43000000090



\$369.00

Wall Cabinet #33
SKU#43000000033



\$1,639.00

JobMaster Rolling Cabinet #100
SKU#43000000100

SAFETY FIRST

TRI-BORO OFFERS A FULL LINE OF SAFETY PRODUCTS

EAR PLUGS

CORDED **\$39.49**
200/CARTON
SKU# 102046

UNCORDED .. **\$20.89**
200/CARTON
SKU# 102025



HARD HATS

with Ratchet

MSA **\$16.95** ea.
orange, white, yellow, blue, gray, red



ERB **\$12.49** ea.
red, orange, white, yellow, blue, tan

Pencil Clip **.94¢**
SKU # 103124

DUST MASKS

N95 - 20/CARTON
SKU# 104215
\$25.79



WITH EXHALATION
VALVE - 10/CARTON
SKU# 104216

\$25.79



Specializing in
Quality Fall
Protection and
Rescue / Recovery
Systems



600 SERIES

SKU#100575 L
SKU#100576 XL

\$61.50

Lightweight Series
Great, All-Around Series



ROOF ANCHOR SYSTEM

SKU#100603
RKB-1715-50

\$129.50

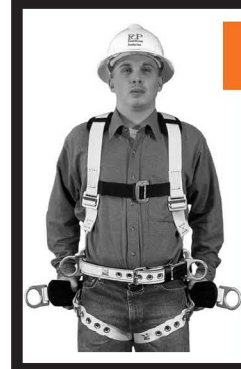

800 SERIES

SKU#100540 L
SKU#100545 XL

\$115.50

Industrial & Construction Series

SAFETY VEST

\$16.95



CLASS 3
(Lime Yellow w/ Contrasting Strip)
L/XL, 2x/3x, 4x/5x
SKU# 107061 / 107062, 107063

SAFETY GLASSES

VARIOUS STYLES



\$4.99

BANRAJ
CLEAR LENS
SKU#101500



\$9.99

WOLVERINE
MIRROR LENS
SKU#101510



\$11.99

DAKURA
CAMOUFLAGE - SMOKE LENS
SKU#101520

SAFETY VEST

carhartt®



CLASS II VEST

(Lime, w/ Stripe) L, XL, 2XL

SKU# 67116549 / 67116556 / 67116563



**S75
Straw
Fiber**

(12 Month)
8' x 112' 6"
SKU#350021

\$40.⁹⁵/roll

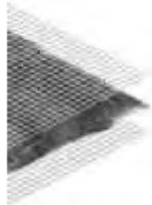

**C125
Coconut
Fiber**

(36 Month)
6.67' x 108'
SKU#350019

\$98.⁹⁰/roll



**SC250 Straw/
Coconut
Matrix**

(Permanent)
6.5' x 55.5'
SKU#350017

\$135.⁵⁰/roll

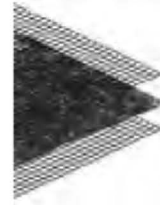

**P300
UV-Stabilized
Polypropylene
Fiber**

(Permanent)
6.67' x 108'
SKU#350018

\$249.⁰⁰

**American
Excelsior
Company**



**Curlex Excelsior
Blanket 4' x 101.25'**
SKU#350013
\$22.50

**Curlex Excelsior
Blanket 8' x 101.25'**
SKU#350014
\$42.95

**Curlex Staples
1" x 6" x 6" 1,000/Box**
SKU#350027
\$38.90

**Curlex Staples
1" x 4" x 4" 500/Box**
SKU#350028
\$32.50

**Roundtop Soil
Pins 6" 1,000/Box**
SKU#350033
\$59.95

**Roundtop Soil
Pin Pounder Tool**
SKU#350035
\$49.95

WHILE SUPPLIES LAST!

MASONRY PRODUCTS

CARLISLE PREKLEENED EPDM FLASHING

12" X 100'	\$84.00
SKU# 324105.....	
18" X 100'	\$126.00
SKU# 324108.....	
24" X 100'	\$168.00
SKU# 324109.....	

DRIP EDGE

1½" X 8' S/S 26 GAGE	\$6.69 ea.
SKU# 281701.....	
3" X 8' S/S 26 GAGE	\$7.85 ea.
SKU# 281703.....	

H & B TEXTROFLASH™

THRU-WALL FLASHING,
SURFACE-MOUNTED FLASHING

12" X 75'	\$39.00 ea.
SKU# 324092.....	
16" X 75'	\$52.00 ea.
SKU# 324094.....	
18" X 75'	\$58.50 ea.
SKU# 324096.....	
20" X 75'	\$65.00 ea.
SKU# 324098.....	
24" X 75'	\$78.00 ea.
SKU# 324100.....	



SCAFFOLD PLANK LAMINATED



9½" X 9'	\$29.50
SKU# 421500.....	
9½" X 10'	\$32.80
SKU# 421497.....	
9½" X 16'	\$52.50
SKU# 421499.....	

W.R. MEADOWS HYDRASET FREE

5 GAL	\$74.95
SKU# 090055	

MORTAR PAN



POLY 3cf BRENTWOOD	
SKU# 034790.....	\$32.95 ea.
STEEL 3cf JACKSON	
SKU# 034760.....	\$31.95 ea.

BIL-JAX SCAFFOLD

5'w x 5' h	\$83.65
SKU# 421250.....	
5'w x 6'-6" h	\$105.75
SKU# 421260.....	
7' Brace	\$23.95
SKU# 421340.....	
7'-6" Brace	\$25.95
SKU# 421330.....	
9" Collar Pin	\$3.25
SKU# 421310.....	
15" Screw Jack	\$42.95
SKU# 421405.....	



TEK SCREWS

CLIMASEAL FINISH	
#10 X 1½"	
SKU# 283020	
.07¢ ea. (250/carton)	



VENEER ANCHORS

DW-10HS® HOT DIPPED GALVANIZED	SKU# 282940
.28¢ ea.	



3" X 3" TRI-TIE HOT DIPPED GALVANIZED	SKU# 282140
\$53.95 /carton (250)	

WHEELBARROWS



JACKSON	
M6 6CU FT METAL SKU# 752030.....	\$119.50
M6 6CU FT METAL FLAT FREE SKU# 752033.....	\$129.50
MP575 5-3/4 CU FT POLY SKU# 752038.....	\$159.50
BP8 8 CU FT POLY SKU# 752039.....	\$99.50



BRENTWOOD	
6CF DOUBLE WHEEL POLY ACWB20477 SKU# 752060.....	\$259.00
6CF DOUBLE WHEEL POLY ACWB11663 SKU# 752063.....	\$139.00
8CF DOUBLE WHEEL ACWB20479 SKU# 752080.....	\$269.00

ELECTRIC HEAT ROD

55 GAL. DRUM

Ideal for Masons to have hot water and thawed sand

SKU# 142000.....	\$319.95
------------------	-----------------

HONDA

GENERATORS

Call For Pricing

TRI-BORO SUPPLIES
(800) 632-9018

EU1000i SKU# 447160

- 1000 watts (8.3 A) of Honda inverter 120V AC
- Super quiet - 53 to 59 dB(A) - super lightweight
- Eco-Throttle™ (runs up to 8.3 hrs on 0.6 gal. of fuel)
- Simultaneous AC/DC use (auto battery charging)
- Advanced inverter technology provides reliable power to computers and other sensitive equipment
- Parallel with other EU1000iA2 for additional power



EU2000i SKU# 447162

- 2000 watts (16.7A) of Honda inverter 120V AC
- Super quiet - 53 to 59 dB(A)
- Lightweight (less than 47 lbs.)
- Eco-Throttle™ - runs up to 15 hrs on 1 gal. of fuel
- Advanced inverter technology provides reliable power to computers and other sensitive equipment
- Simultaneous AC/DC use (auto battery charging)
- Parallel with other EU2000i for additional power

EU3000i SKU# 447165

- 3000 watts (25 A) of Honda inverter 120V AC
- Super quiet operation - 49 to 58 dB(A)
- Eco-Throttle™ - runs up to 20 hrs. on 3.4 gal. of fuel
- Convenient electric starting
- Advanced inverter technology provides reliable power to computers and other sensitive equipment
- Parallel with other EU3000i for additional power
- Simultaneous AC/DC use (auto battery charging)

EU3000i handi SKU# 447166

- 3000 watts (25 A) of Honda inverter 120V AC power
- Super quiet operation - 57 to 65 dB(A)
- Max output to start most RV AC units in the 13.5 BTU class
- Eco-Throttle™ [runs up to 7.7 hours on 1.56 gals of fuel]
- Advanced inverter technology provides reliable power to computers and other sensitive equipment
- Parallel with another EU3000i handi for additional power
- 12v - 8A DC output



EB3000CK2A SKU# 447210

- 3000 watts (25A) of 120V
- Super lightweight (only 68.4 lbs.)
- Powerful Honda 6.5 HP OHV engine
- Operates 9.3 hrs. at 50% load (2.7 gal.)
- G.F.C.I. duplex receptacle

EB4000XAT SKU# 447229

- 4000 watts, 120/240V
- Provides 5,000 watts for 10 secs to start larger equipment
- Honda commercial iGX engine & heavy duty frame
- Full GFCI protection
- Long run time - up to 16 hrs at 50% load
- 120/240V selector switch
- 2 wheel kit & lift hook

EB5000XK3AT SKU# 447236

- 5000 watts (41.7/20.8 A) 120/240V
- Operates 11.2 hours at 50% load (6.2 gal.)
- 2 duplex receptacles
- One-piece welded frame w/full frame protection
- Voltage selector switch - 120/240V operation
- Automatic idle
- All circuit - G.F.C.I. protected
- 2-wheel kit and lift hook standard



EB6500X1AT SKU# 447251

- 6500 watts, 120/240V
- Provides 7,000 watts for 10 secs to start larger equipment
- Honda commercial iGX engine & heavy duty frame
- Full GFCI protection
- Long run time - up to 10.4 hrs
- 120/240V selector switch
- 2 wheel kit & lift hook

PUMPS

WT20X SKU# 446100

- Heavy-duty 2" construction trash pump
- Easy-start 5.5hp OHV commercial engine
- 187 gal./min. capacity
- Solid handling capability up to 1 3/16"
- Easy-to-use quick clean out port
- Easy-to-service impeller wear plate
- Standard strainer and service tool

WT30X SKU# 446110

- Heavy-duty 3" construction trash pump
- Easy-start 8 HP OHV commercial engine
- Full frame protection
- 319 gal./min. capacity
- Solid handling capability up to 1 1/16"
- Easy-to-use quick clean out port
- Standard strainer and service tool
- Easy-to-service impeller wear plate

WT20X/WT30X/WT40X



WT40XK2A SKU# 446115

- Heavy-duty 4" construction trash pump
- Easy starting Honda OHV commercial engine
- 433 gal./min capacity
- Solid handling capability up to 1 1/16"
- Cast iron volute and impeller
- Quick clean out port

WB20X



WB20XK2 SKU# 446095

- Centrifugal, self priming 2" pump
- 152 gal./min. capacity
- Easy starting, 4hp OHV commercial engine
- Silicon carbide mechanical seal
- Cast iron volute and impeller
- Heavy-duty full frame protection
- Isolation mounted engine and pump

Call For Pricing

TRI-BORO SUPPLIES (800) 632-9018

For optimum performance and safety, please read the owner's manual before operating your Honda Power Equipment. © 2013 American Honda Motor Co., Inc. Connection of a generator to house power requires a transfer device to avoid possible injury to power company personnel. Consult a qualified electrician. © 2013 American Honda Motor Co., Inc.

STIHL®

BLOWERS

\$149.95



BG 55 Handheld Blower
OCCASIONAL USER
SKU# 480006

STIHL® HomeScaper Series™

BG86 \$239.95
BLOWER SKU# 480029

Part of our new line of low emissions handheld STIHL leaf blowers, the BG 86 has all the comfort features you need to work for hours at a time. This professional use gas leaf blower is equipped with a throttle lock and stop switch, along with a semi-automatic choke lever for smoother starts and ease of operation. Designed with our four-spring anti-vibration system, this leaf and debris blower is both powerful and fuel efficient—letting you run longer between fuel stops.



BR350 Blower \$369.95

SKU# 480046

When your landscape calls for professional-grade tools, turn to the STIHL BR 350 backpack blower. Its powerful and fuel-efficient gasoline-powered engine provides enough rugged power to tackle heavy debris, while delivering exceptional fuel economy and lower emissions than previous models. The anti-vibration technology enhances operator comfort during long runs, which are made possible by a large 57.5 oz. fuel tank. All told, the BR 350 is one of our best backpack blower values for larger properties, ranches, and farms.



BR600 \$499.95
BACKPACK BLOWER
SKU# 480044

Our newest and most POWERFUL blower. Powered by the STIHL 4-MIX® engine that combines power, performance and low emissions.



SAWS

TS410 -12" \$839.95

SKU# 4801590

12" WITH DIAMOND BLADE

SKU# 540438 **\$879.95**



TS420 -14" \$879.95

SKU# 4801591

14" WITH DIAMOND BLADE

SKU# 540662 **\$919.95**



Stihl's Cutquick offers the IntelliCarb™ Carburetor compensator system. Other exclusive features include a semi-automatic belt tensioner, ElastoStart handle and Easy Start System. The TS410 and TS420 are easy to start and maintain and are exceptionally well-balanced. Choose either a 12" or 14" wheel.

STIHL® CHAIN SAWS

SAVE NOW ON THE QUALITY OF STIHL!



MS 290 FARM BOSS

\$379.95 16" Bar

SKU# 480639

Our most popular model. The name says it all. Side access chain tensioner and IntelliCarb™ compensating carburetor.



MS 181 CHAIN SAW

\$259.95 16" Bar

SKU# 480597

This small chain saw has a powerhead weight of less than 10 pounds, and utilizes some of the same features found on our bigger saws, including a pre-separation air filtration system that means less maintenance for you. And if you're an eco-conscious consumer, you'll appreciate that this saw uses reduced-emission technology, without compromising on power.



MS 251 CHAIN SAW

\$359.95 18" Bar

SKU# 4910373

The STIHL MS 251 Chain Saw is designed to deliver all the power you'd expect from STIHL equipment, yet with a comfortable and ergonomic design. It is perfect for felling small trees, pruning and thinning, and cutting firewood simply and efficiently.

FULLY ASSEMBLED AND SERVICED. WHILE QUANTITIES ARE AVAILABLE

TRI-BORO CONSTRUCTION SUPPLIES Pricing in flyer good from December 1, 2013 until March 19, 2014

MILLER FALL PROTECTION

BODY WEAR



**Miller Contractor
Harness**

\$99.00

SKU# 100200
#650CN-BDP



**Miller HP
Harness**

\$54.90

SKU# 100205
#650T



**Miller Titan
Harness**

\$42.50

SKU# 100210
#T4500

SHOCK ABSORBING LANYARDS



**Miller HP 6'
Shock Absorbing
Lanyard**

\$35.95

SKU# 100230
#216TWLS-Z7



**Miller Titan
6' Stretch
Lanyard**

\$44.95

SKU# 100235
#T5112

FALL LIMITERS / RETRACTABLES



**Miller 11' Mini-Lite
Fall Limiter**

\$129.95

SKU# 100310
#FL11-3-Z7



**Miller Self
Retracting
Lifeline**

20' \$339.00

SKU# 100305
#MP20G-Z7

30' \$379.00

SKU# 100306
#MP30G-Z7



Construction Supply

465 Locust St. Dallastown, PA 17313 USA • Ph 800.632.9018 • Fax 717.246.3506

1490 Ritner Hwy. Carlisle, PA 17013 USA • Ph 800.248.6590 • Fax 717.249.9696

Pricing in flyer good from December 1, 2013 until March 19, 2014

MILLER FALL PROTECTION

CARABINERS



**Miller 400LB
Carabiner**
\$29.⁹⁵

SKU# 100285
#17D-1



**Miller 400LB 2\"/>
Open Carabiner**
\$48.⁹⁵

SKU# 100290
#18D-1

ANCHORAGE & POSITIONING PRODUCTS

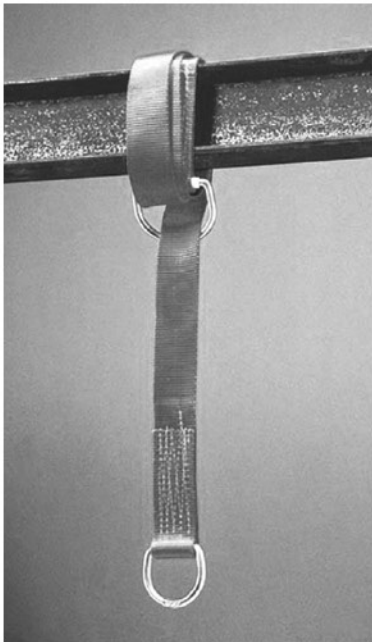

**Miller 6' Cross
Arm Strap**
\$29.⁵⁰

SKU# 100283
#8183



**Miller Adjustable
Beam Anchor**
\$179.⁹⁰

SKU# 100280
#8816-14



**Miller Rebar
Positioning
Assembly**
\$45.⁹⁰

SKU# 100240
#T8221



465 Locust St. Dallastown, PA 17313 USA • Ph 800.632.9018 • Fax 717.246.3506

1490 Ritner Hwy. Carlisle, PA 17013 USA • Ph 800.248.6590 • Fax 717.249.9696

Pricing in flyer good from December 1, 2013 until March 19, 2014